

Ergebnis: **315.4** (299)
 Serien: 105.4 105.0 105.0
 Zähler: 29 1 0 0 0 0 0 0 0 0
 Innenzehner: 28
 weiteste: 256 (13), 211 (12), 190 (28)
 beste Teiler 17.7 (8.) 39.3 (11.) 42.7 (14.)
 Trefferlage 0.23 mm links, 0.26 mm tief
 Streuwert 0.85, horizontal: 0.84, vertikal: 0.87

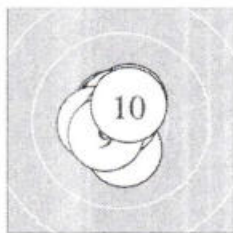

Serie 1:
 10.6 * 10.6 * 10.5 * 10.6 * 10.6 *
 10.3 * 10.3 * 10.9 * 10.5 * 10.5 *
 beste Teiler 17.7 (8.) 80.9 (2.) 88.3 (4.)
 Trefferlage 0.35 mm links, 0.14 mm hoch
 Streuwert 0.79, horizontal: 0.65, vertikal: 0.92

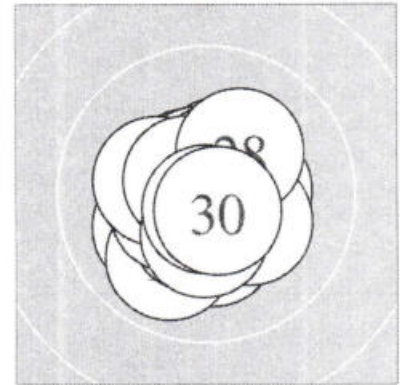
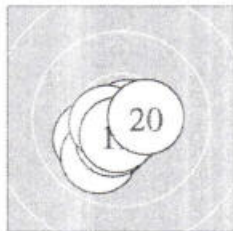

Serie 2:
 10.8 * 10.1 ↙ 9.9 ↘ 10.8 * 10.7 *
 10.7 * 10.4 * 10.6 * 10.6 * 10.4 *
 beste Teiler 39.3 (11.) 42.7 (14.) 51.8 (15.)
 Trefferlage 0.28 mm links, 0.68 mm tief
 Streuwert 0.82, horizontal: 0.91, vertikal: 0.71

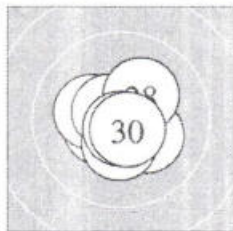

Serie 3:
 10.4 * 10.7 * 10.2 * 10.6 * 10.3 *
 10.4 * 10.8 * 10.2 * 10.7 * 10.7 *
 beste Teiler 50.2 (27.) 52.0 (29.) 68.5 (30.)
 Trefferlage 0.06 mm links, 0.24 mm tief
 Streuwert 0.92, horizontal: 0.99, vertikal: 0.84

Jordan Barbara
 Unterschrift des Schützen

Schützengesellschaft
 Neustadt 1893 e.V.
 782 Titisee-Neustadt 1

Meyton Elektronik

Ergebnis: **317.1** (300)
 Serien: 104.7 107.1 105.3
 Zähler: 30 0 0 0 0 0 0 0 0 0
 Innenzehner: 28
 weiteste: 250 (6), 235 (4), 186 (7)
 beste Teiler 12.6 (14.) 17.4 (16.) 20.2 (10.)
 Trefferlage 0.09 mm links, 0.02 mm hoch
 Streuwert 0.80, horizontal: 0.79, vertikal: 0.81

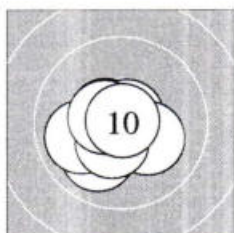
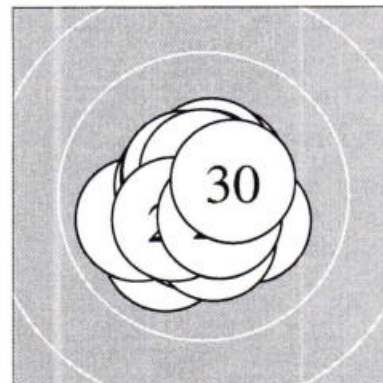

Serie 1:
 10.7 * 10.5 * 10.7 * 10.0 ✓ 10.7 *
 10.0 ← 10.2 * 10.5 * 10.5 * 10.9 *
 beste Teiler 20.2 (10.) 57.3 (3.) 60.4 (1.)
 Trefferlage 0.39 mm links, 0.41 mm tief
 Streuwert 0.97, horizontal: 1.12, vertikal: 0.80

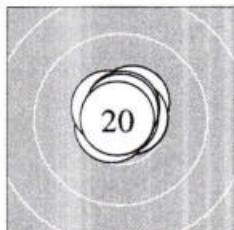

Serie 2:
 10.7 * 10.4 * 10.7 * 10.9 * 10.7 *
 10.9 * 10.5 * 10.7 * 10.7 * 10.9 *
 beste Teiler 12.6 (14.) 17.4 (16.) 22.1 (20.)
 Trefferlage 0.05 mm rechts, 0.32 mm hoch
 Streuwert 0.46, horizontal: 0.49, vertikal: 0.43

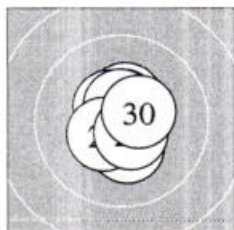

Serie 3:
 10.4 * 10.7 * 10.3 * 10.6 * 10.7 *
 10.5 * 10.6 * 10.4 * 10.6 * 10.5 *
 beste Teiler 52.3 (22.) 55.0 (25.) 92.7 (24.)
 Trefferlage 0.05 mm rechts, 0.15 mm hoch
 Streuwert 0.81, horizontal: 0.60, vertikal: 0.97

Handwritten signature of the shooter.

Unterschrift des Schützen

Schützengesellschaft
 Neustadt 1823 e. V.
 782 Neustadt I

Meyton Elektronik

Ergebnis: **314.5** (299)
 Serien: 105.8 104.4 104.3
 Zähler: 29 1 0 0 0 0 0 0 0 0
 Innenzehner: 26
 weiteste: 253 (28), 220 (21), 219 (17)
 beste Teiler 18.0 (1.) 28.2 (23.) 31.0 (2.)
 Trefferlage 0.64 mm links, 0.31 mm tief
 Streuwert 0.81, horizontal: 1.00, vertikal: 0.55

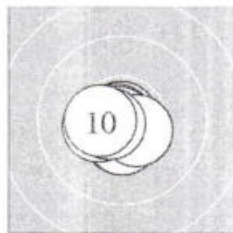
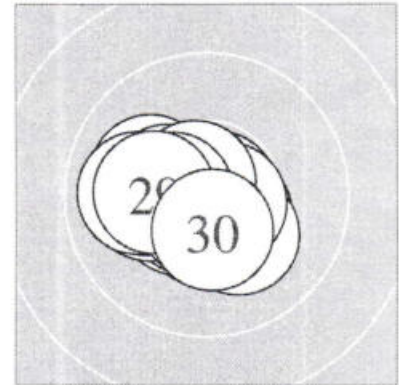

Serie 1:
 10.9 * 10.8 * 10.4 * 10.5 * 10.8 *
 10.5 * 10.4 * 10.5 * 10.6 * 10.4 *
 beste Teiler 18.0 (1.) 31.0 (2.) 31.3 (5.)
 Trefferlage 0.49 mm links, 0.38 mm tief
 Streuwert 0.63, horizontal: 0.76, vertikal: 0.46

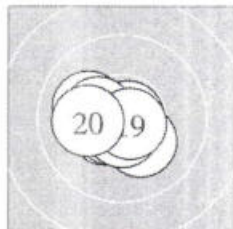

Serie 2:
 10.2 * 10.5 * 10.6 * 10.4 * 10.8 *
 10.6 * 10.1 ← 10.4 * 10.7 * 10.1 ←
 beste Teiler 39.5 (15.) 62.6 (19.) 86.0 (16.)
 Trefferlage 0.66 mm links, 0.29 mm tief
 Streuwert 0.93, horizontal: 1.14, vertikal: 0.64

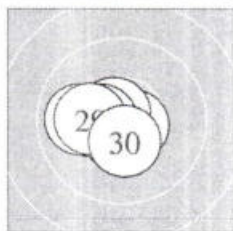

Serie 3:
 10.1 ← 10.5 * 10.8 * 10.7 * 10.6 *
 10.7 * 10.4 * 9.9 ← 10.2 * 10.4 *
 beste Teiler 28.2 (23.) 66.6 (26.) 75.0 (24.)
 Trefferlage 0.76 mm links, 0.25 mm tief
 Streuwert 0.91, horizontal: 1.14, vertikal: 0.60

 Unterschrift des Schützen

Schützengesellschaft
 Neustadt 1873 e. V.
 782 Titisee-Neustadt 1

Meyton Elektronik

Ergebnis: **316.1** (300)
 Serien: 104.4 104.9 106.8
 Zähler: 30 0 0 0 0 0 0 0 0 0
 Innenzehner: 25
 weiteste: 244 (15), 238 (13), 215 (10)
 beste Teiler 13.4 (25.) 14.8 (23.) 32.0 (29.)
 Trefferlage 0.39 mm rechts, 0.01 mm hoch
 Streuwert 0.85, horizontal: 1.00, vertikal: 0.67

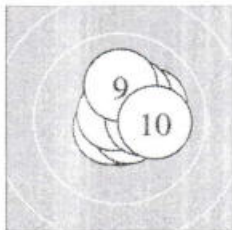
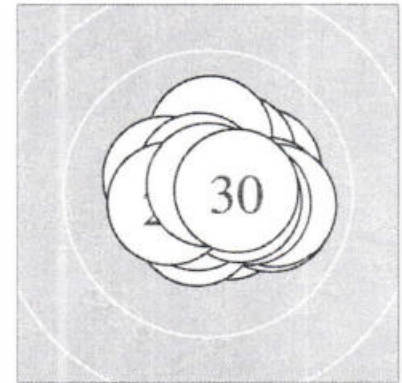

Serie 1:
 10.6 * 10.7 * 10.1 → 10.3 * 10.6 *
 10.7 * 10.8 * 10.4 * 10.1 ↑ 10.1 →
 beste Teiler 47.0 (7.) 60.0 (2.) 71.4 (6.)
 Trefferlage 0.69 mm rechts, 0.29 mm hoch
 Streuwert 0.91, horizontal: 0.93, vertikal: 0.90

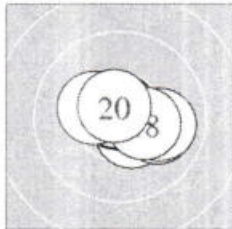

Serie 2:
 10.8 * 10.5 * 10.0 → 10.8 * 10.0 →
 10.8 * 10.8 * 10.3 * 10.3 * 10.6 *
 beste Teiler 32.2 (14.) 41.5 (17.) 42.4 (16.)
 Trefferlage 0.48 mm rechts, 0.02 mm hoch
 Streuwert 0.97, horizontal: 1.26, vertikal: 0.56



Serie 3:
 10.5 * 10.8 * 10.9 * 10.8 * 10.9 *
 10.7 * 10.5 * 10.4 * 10.8 * 10.5 *
 beste Teiler 13.4 (25.) 14.8 (23.) 32.0 (29.)
 Trefferlage 0.00 mm , 0.25 mm tief
 Streuwert 0.59, horizontal: 0.73, vertikal: 0.40

Ulrike Braun

Unterschrift des Schützen

Schützengesellschaft
 Neustadt
 782 Tübingen
 Neustadt 1

Meyton Elektronik

Ergebnis: **317.1** (300)
 Serien: 105.5 106.3 105.3
 Zähler: 30 0 0 0 0 0 0 0 0 0
 Innenzehner: 27
 weiteste: 241 (22), 209 (1), 206 (14)
 beste Teiler 5.3 (21.) 13.3 (18.) 17.4 (3.)
 Trefferlage 0.22 mm rechts, 0.19 mm tief
 Streuwert 0.79, horizontal: 0.83, vertikal: 0.74

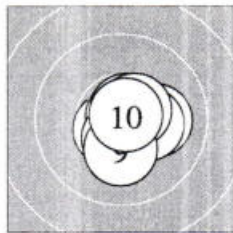
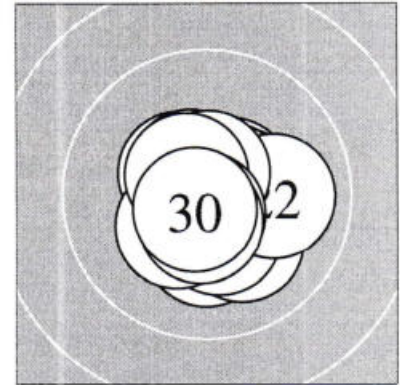

Serie 1:
 10.1 → 10.6 * 10.9 * 10.7 * 10.8 *
 10.3 * 10.6 * 10.5 * 10.2 * 10.8 *
 beste Teiler 17.4 (3.) 38.9 (10.) 48.1 (5.)
 Trefferlage 0.47 mm rechts, 0.26 mm tief
 Streuwert 0.79, horizontal: 0.83, vertikal: 0.75

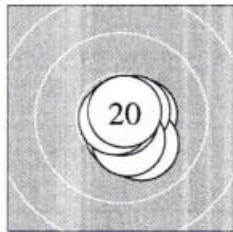

Serie 2:
 10.8 * 10.5 * 10.6 * 10.1 ↘ 10.8 *
 10.6 * 10.4 * 10.9 * 10.8 * 10.8 *
 beste Teiler 13.3 (18.) 26.0 (11.) 30.3 (15.)
 Trefferlage 0.38 mm rechts, 0.30 mm tief
 Streuwert 0.64, horizontal: 0.52, vertikal: 0.75

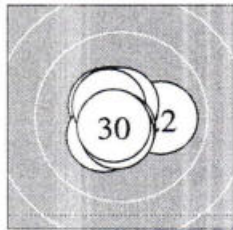

Serie 3:
 10.9 * 10.0 → 10.5 * 10.5 * 10.3 *
 10.6 * 10.5 * 10.7 * 10.6 * 10.7 *
 beste Teiler 5.3 (21.) 69.4 (28.) 69.5 (30.)
 Trefferlage 0.17 mm links, 0.02 mm tief
 Streuwert 0.89, horizontal: 0.99, vertikal: 0.77

P. Jordan
 Unterschrift des Schützen

Schützengesellschaft
 Neustadt 1893 e.V.
 782 Titisee-Neustadt 1

Meyton Elektronik

Ergebnis: **313.1** (298)
 Serien: 105.3 103.8 104.0
 Zähler: 28 2 0 0 0 0 0 0 0 0
 Innenzehner: 25
 weiteste: 281 (18), 251 (17), 247 (1)
 beste Teiler 27.0 (10.) 31.0 (3.) 37.0 (12.)
 Trefferlage 0.37 mm rechts, 0.41 mm hoch
 Streuwert 0.97, horizontal: 1.21, vertikal: 0.64

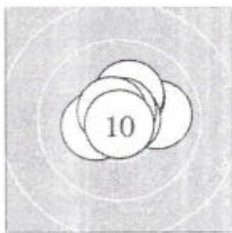
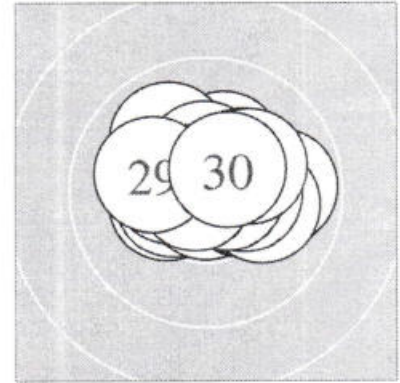

Serie 1:
 10.0 → 10.3 * 10.8 * 10.3 * 10.7 *
 10.2 * 10.8 * 10.7 * 10.7 * 10.8 *
 beste Teiler 27.0 (10.) 31.0 (3.) 44.5 (7.)
 Trefferlage 0.25 mm rechts, 0.49 mm hoch
 Streuwert 0.85, horizontal: 1.00, vertikal: 0.67

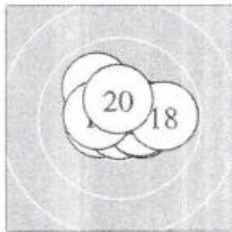

Serie 2:
 10.4 * 10.8 * 10.7 * 10.4 * 10.6 *
 10.4 * 9.9 ↘ 9.8 → 10.4 * 10.4 *
 beste Teiler 37.0 (12.) 54.0 (13.) 100.3 (15.)
 Trefferlage 0.25 mm rechts, 0.36 mm hoch
 Streuwert 1.13, horizontal: 1.39, vertikal: 0.78

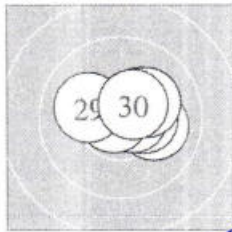

Serie 3:
 10.4 * 10.1 → 10.3 * 10.6 * 10.4 *
 10.6 * 10.8 * 10.2 * 10.1 ↖ 10.5 *
 beste Teiler 42.0 (27.) 78.0 (26.) 80.4 (24.)
 Trefferlage 0.62 mm rechts, 0.38 mm hoch
 Streuwert 0.98, horizontal: 1.29, vertikal: 0.52

Joachim Willmann
 Unterschrift des Schützen

Schützengesellschaft
 Neustadt 1822 e. V.
 782 Tilsiter-Neustadt 1

Meyton Elektronik